



AIRCHARGER™

HIGH-FLOW INTAKE KITS



INSTALLATION INSTRUCTIONS

63-1121
YAMAHA
2008-13 Rhino
700cc FI

TOOLS NEEDED:

- 3mm Allen Wrench
- 4mm Allen Wrench
- 10mm Socket
- 10mm Wrench
- Extension
- Flat Blade Screwdriver
- Ratchet

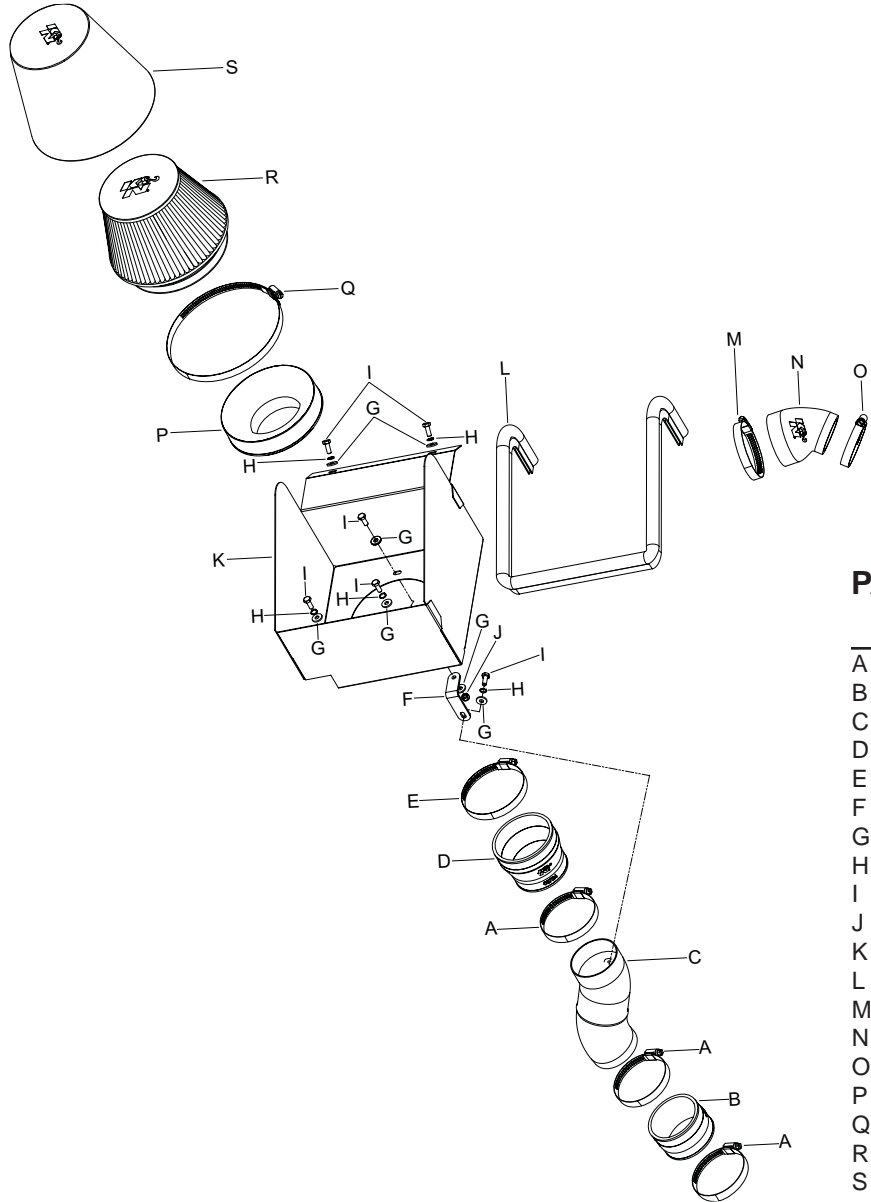

PARTS LIST:

Description	Qty.	Part #
A Hose Clamp #48	3	08601
B Hose; 3"ID X 2"L, Black Silicone	1	08434
C Intake Tube	1	27550
D Hose; 3.5"ID to 3"ID TPRD., Silicone	1	08724
E Hose Clamp #56	1	08620
F Bracket; "L", Fin.	1	07093
G Washer; 1/4"ID X 5/8"OD - SAE	7	08275
H Washer; 1/4" Lock, ZN	5	08198
I Bolt; 6mm-1.00 X 16mm, SS	6	07812
J Nut; 6mm Nylock, Hex Head, SS	1	07512
K Heat Shield	1	074042
L Edge Trim (39")	1	102496
M Hose Clamp #44	1	08560
N Hose; 2.125"ID to 2.84"ID X 4.25"L, Sil.	1	084096
O Hose Clamp #36	1	08530
P Adaptor; #380	1	21512
Q Hose Clamp #104	1	08697
R Air Filter	1	RC-2960XD
S Drycharger®	1	22-8049DK

NOTE: The K&N® Drycharger® included with this kit must be installed on the K&N® air filter because of the harsh terrain conditions these vehicles are intended to operate in. Please be aware the Drycharger® is water repellent, not water proof. The K&N® high flow intake system is a performance product that can be used safely during mild and inclement weather conditions if used as directed. Failure to follow these instructions can void your warranty.

NOTE: FAILURE TO FOLLOW INSTALLATION INSTRUCTIONS AND NOT USING THE PROVIDED HARDWARE MAY DAMAGE THE INTAKE TUBE, THROTTLE BODY AND ENGINE.

TO START:

1. Turn off the ignition and disconnect the negative battery cable.



2. Release the locking lever and remove the drivers and passenger seats.



3. Lift up the engine cover and remove it from the vehicle as shown. It will be necessary to push the shifter boot through the engine cover as it is removed.

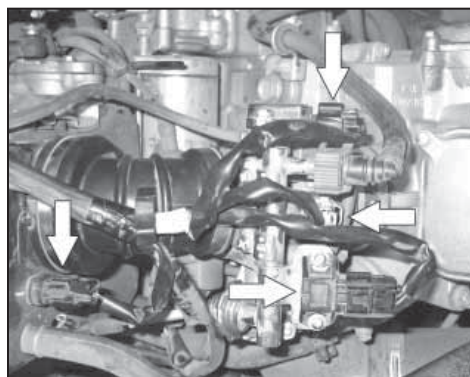

4. Unhook the four fuel injection electrical connections shown and place the wiring harness to the side away from the intake hose.

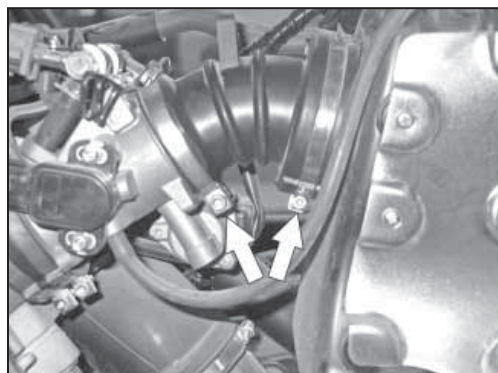

5. Loosen the two hose clamps which secure the stock intake hose to the throttle body and air chamber.



6. Remove the stock intake hose from throttle body and out of the air chamber as shown.



7. Install the provided hose clamps onto the K&N® silicone hose (084096) as shown.

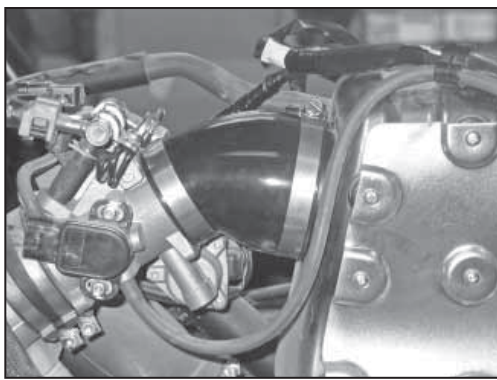

8. Install the silicone hose assembly onto the throttle body and air chamber and secure with the hose clamps.

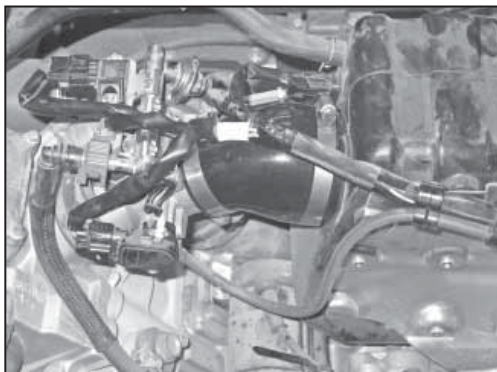

9. Reconnect the fuel injection electrical connections.

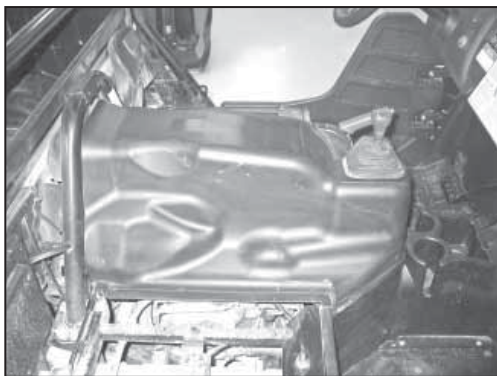

10. Reinstall the factory engine cover.



11. Reinstall the drivers and passenger seat.



12. Remove the two deflector shield fasteners shown.

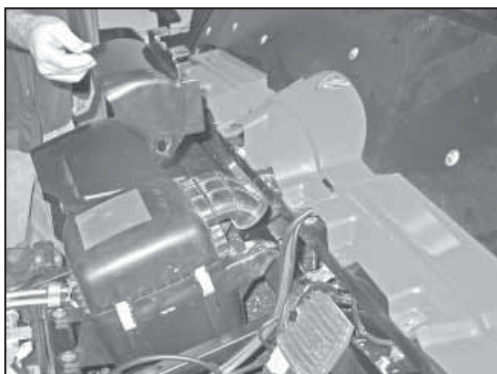

13. Remove the deflector shield as shown.

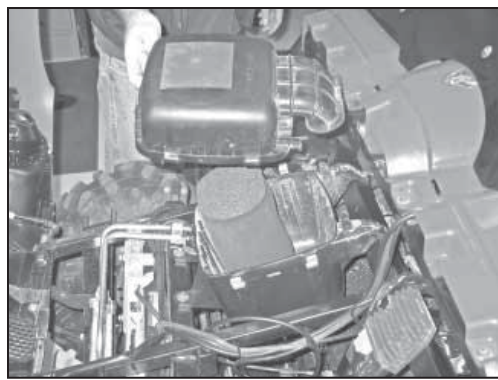

14. Unclip the five air box lid clips and remove the air box lid from the air box base.

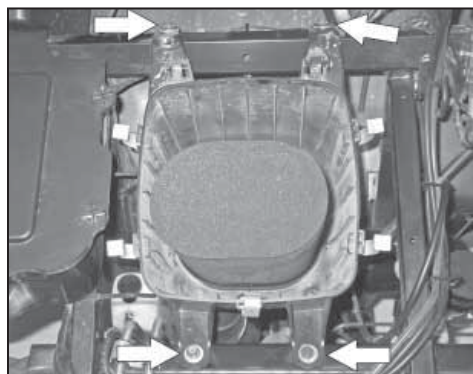

15. Remove the four air box mounting bolts shown.

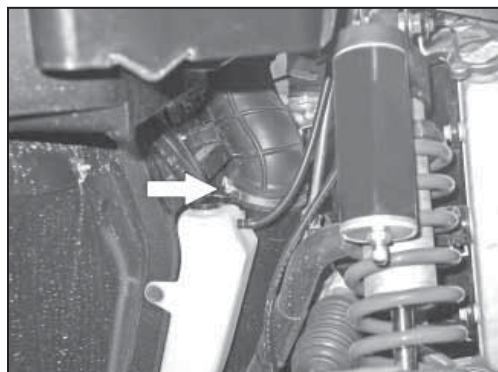

16. Loosen the hose clamp which secures the intake tube to the lower air box.

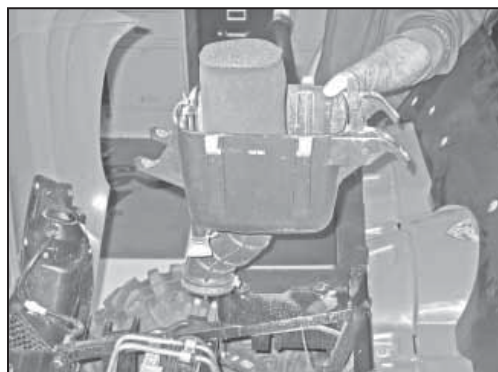

17. Remove the lower air box from the vehicle as shown.

NOTE: K&N Engineering, Inc., recommends that customers do not discard factory air intake.

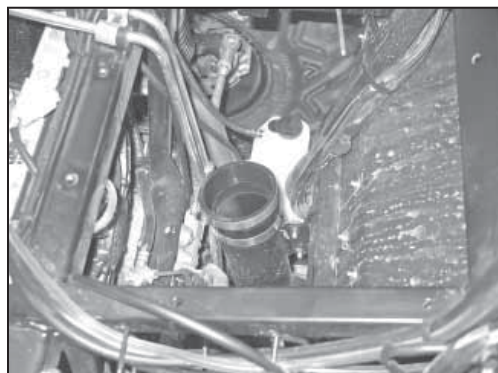

18. Install the provided silicone hose (08434) onto the intake tube and secure with the provided hose clamp.

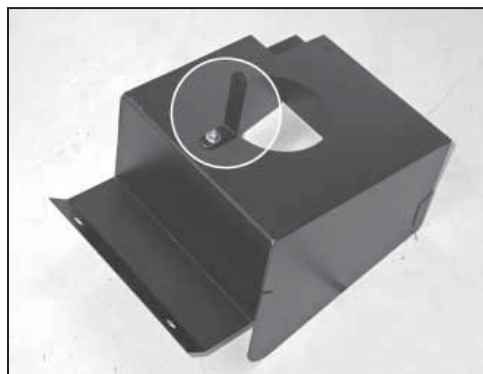

19. Install the provided tube mounting bracket (07093) onto the heat shield as shown.

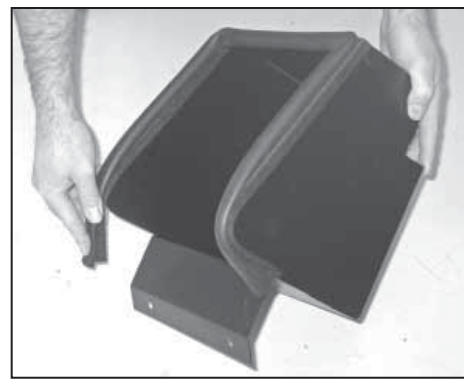

20. Install the provided edge trim onto the heat shield as shown.

NOTE: Some trimming of the edge trim will be necessary.

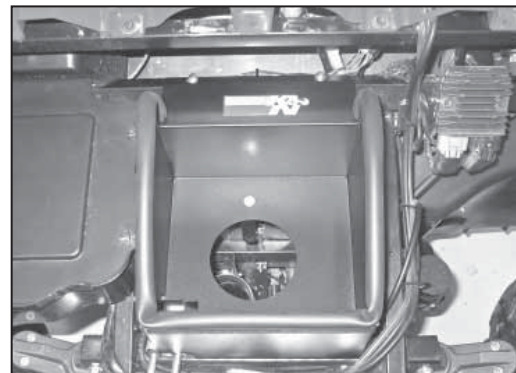

21. Install the heat shield assembly into the vehicle and secure with the provided hardware to the factory air box mounting locations.



22. Install the provided filter adapter into the K&N® air filter and secure with the provided hose clamp.

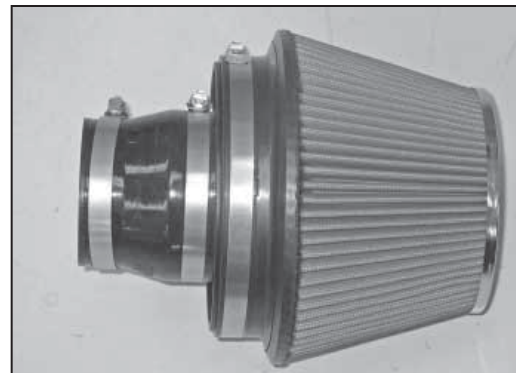

23. Install the silicone hose (08724) onto the filter adapter and secure with the provided hose clamp.



24. Install the K&N® Drycharger® onto the air filter as shown.

NOTE: Please be aware the Drycharger® is water repellent, not water proof. Depending on conditions and usage the water repellent treatment is good for 1 to 2 years. See the parts list to reorder a new Drycharger® if necessary.

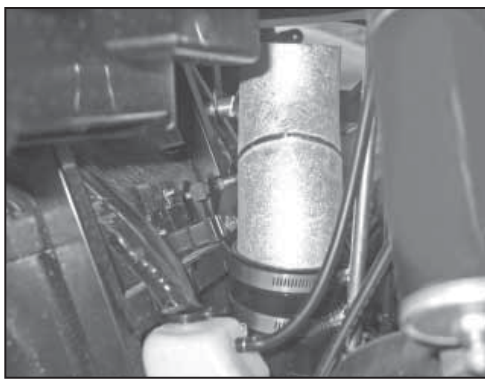

25. Install the K&N® intake tube into the silicone hose and align with the tube mounting bracket installed onto the heat shield, then secure the intake tube with the hose clamp and hardware provided.

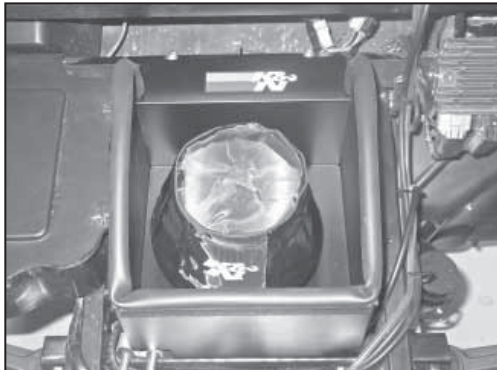

26. Install the K&N® air filter assembly onto the intake tube and secure with provided hose clamp.

27. Reconnect the vehicle's negative battery cable. Double check to make sure everything is tight and properly positioned before starting the vehicle.

28. It will be necessary for all K&N® high flow intake systems to be checked periodically for realignment, clearance and tightening of all connections. Failure to follow the above instructions or proper maintenance may void warranty.

ROAD TESTING:

1. Start the engine with the transmission in neutral or park. Listen for air leaks or odd noises. For air leaks secure hoses and connections. For odd noises, find cause and repair before proceeding. This kit will function identically to the factory system except for being louder and much more responsive.

2. Test drive the vehicle. Listen for odd noises or rattles and fix as necessary.

3. If road test is fine, you can now enjoy the added power and performance from your kit.

4. K&N Engineering, Inc., requires cleaning the intake system's air filter element periodically for excessive dirt build-up. When used in harsh terrain conditions or off-road environments, our filters will require cleaning more often. We recommend that you visually inspect your filter more frequently when used in harsh terrain conditions to determine if the screen is still visible. When the screen is no longer visible some place on the filter element, it is time to clean it. To clean and re-oil, purchase our filter Recharger® service kit, part number 99-5050 or 99-5000 and follow the easy instructions.

STREET LEGAL IN MOST STATES

**NOT LEGAL FOR USE IN CA & OTHER STATES
ADOPTING CA EMISSIONS STANDARDS**

See our catalog or knfilters.com for CARB status on each part for a specific vehicle

* FREE K&N® decal To register your warranty, please see us online at knfilters.com/register. FREE K&N® decal *